

MODEL L-PC-1-CL

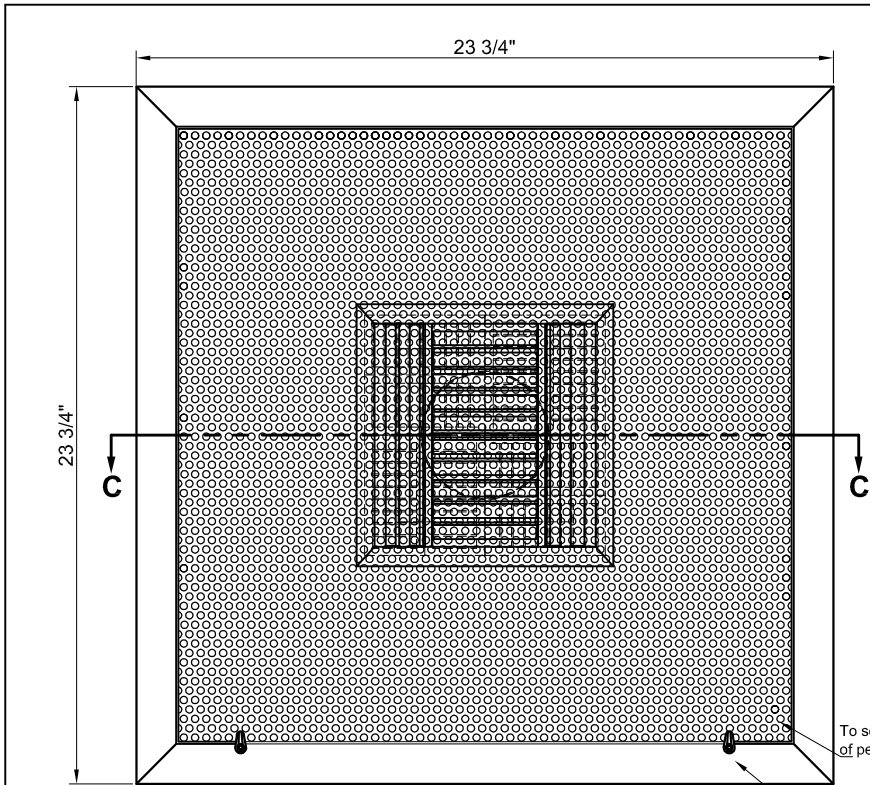

MODEL: L-PC-1-CL
 L-PC-1-CL-D2
 L-PC-1-CL-FB
 L-PC-1-CL-D2-FB
 L-PC-1-CL-OB

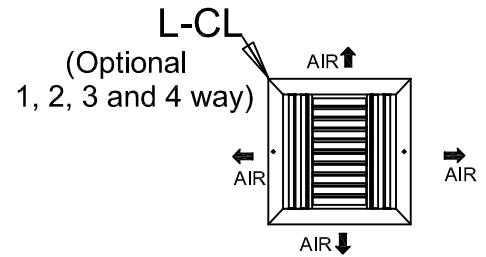

D2-Optional
 (Radial sliding
 blade damper)

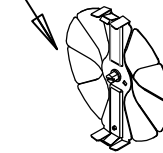

L-OB-Optional

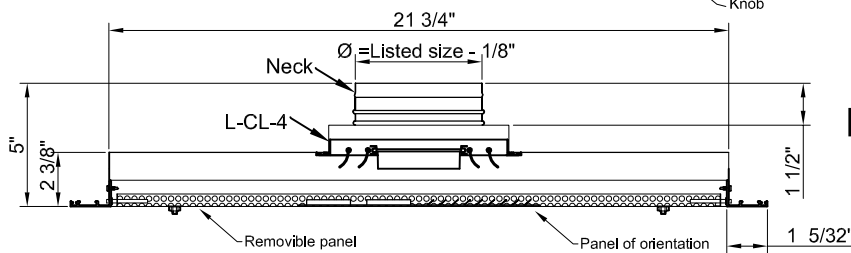
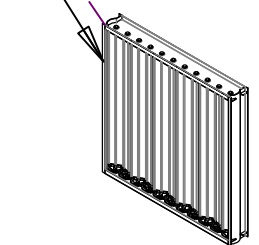

FB-Optional
 (Fiber glass)

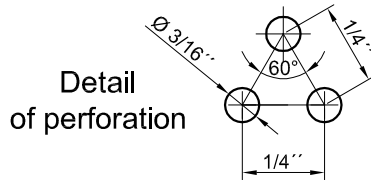
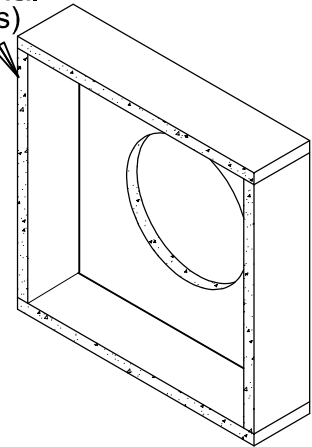

Finish
 White (Standard)
 Other colors (Optional)

Dimensions are in inches

Frame: Extruded aluminum
 Steel Perforated C.R R-5 T7 Cal 0.6 mm

Note 1: Available in sizes 24"x24"

Note 2: Optional L-CL 1, 2, 3 and 4 way, with the size of 4" to 18". grid must be 2", larger than the diameter of the neck.

Note 3: Neck and D2 (Radial sliding blade damper) Optional Available in size ØMN 6", 8", 10", 12", 14".

Job Name: _____
 Location: _____

Architect: _____
 Engineer: _____
 Contractor: _____